

Pressure drop behaviour in a three-dimensional packed bed cell during copper deposition and hydrogen evolution

V. D. STANKOVIĆ*, G. LAZAREVIĆ

Technical Faculty Bor, University of Belgrade, JNA 12, 19210 Bor, Yugoslavia

A. A. WRAGG

School of Engineering, University of Exeter, Exeter EX4 4QF, Great Britain

Received 28 February 1994; revised 10 November 1994

Pressure drop in a three-dimensional packed bed electrode cell has been investigated during electrowinning of copper with simultaneous hydrogen evolution. The presence of gas bubbles in the packed bed electrode leads to an increase in the pressure drop in the electrolyte flowing through the cell. This pressure drop increase was in the range of 30 to 70% relative to the bubble-free case. Parameters such as current density, electrolyte velocity and particle shape greatly influence the pressure drop behaviour. Experimental results are correlated using the Ergun equation and show satisfactorily good agreement in the investigated range of modified Reynolds number.

1. Introduction

Electrochemical reactors with packed beds of conductive materials of different shapes have been extensively investigated over the past two decades with the aim of electrowinning of heavy metal ions from dilute solutions of various origins [1–3].

The phenomenon of pressure drop increase caused by electrolyte flow through packed bed electrodes has been recently demonstrated [4, 5]. Millinger and Simonsson [4] have monitored the pressure drop increase during copper deposition over long term experiments. The marked increase in the pressure drop has been attributed to the decrease in the bed voidage due to the metal deposition on the particles constituting the three dimensional cathode. This effect may become significant after a sufficiently long period of metal deposition, and may lead to increased electrolyte pumping cost.

In the case of the batch recirculating mode of metal winning in galvanostatic conditions, hydrogen evolution occurs as a parallel reaction with metal ion depletion when the operating current density exceeds the limiting current density. The evolution of hydrogen bubbles in the cathodic compartment causes an increase in cell voltage but also an increased resistance to the electrolyte flow, as was first detected by Stankovic and Milanov [5]. The pressure drop behaviour of such two-phase flow has not been studied up to the present, in spite of numerous similar investigations in nonelectrochemical systems [6, 7]. The fact that the hydrogen evolution contributes to the pressure drop increase in the packed bed electrode cell has received no attention. The aim of this work is to investigate the pressure drop behaviour in a

three-dimensional packed bed cathode working in the batch recycle electrowinning mode.

2. Experimental details

Experiments were carried out in the packed bed cell schematically presented in Fig. 1. The cell was of rectangular geometry and was made of Plexiglass: the overall dimensions were 55 mm × 100 mm × 300 mm in height. The cell was separated vertically into anode and cathode compartments by a diaphragm of porous plastic. Side openings were made in one part of the cell, as indicated in Fig. 1, for connection of a differential U-tube manometer [8]. The hydraulic flow circuits consisted of centrifugal pumps, flow meters, valves and tanks for anolyte and catholyte.

Electrolytes were introduced to the cell through the inlet opening at the bottom, leaving the cell by overflows at the top and returned by gravity flow to the reservoirs. The tanks were each filled with 10 dm⁻³ H₂SO₄ solution while the catholyte was either 1 g dm⁻³ Cu²⁺ with 0.5 mol dm⁻³ H₂SO₄, or had the same composition as the anolyte, depending on the experiments to be performed.

A copper sheet was used as a current feeder while the counter electrode was a lead sheet. The current feeder width was equal to the inner cell width dimension, while the active path was equal to the bed height. The rest of the current feeder outside the bed was insulated. The dimensions of the counter electrode were equal to the active part of the current feeder. Different shapes of copper particles such as: spheres, cylinders and scrap were each used as the packed bed three-dimensional cathode. Additionally beds of both graphite Raschig rings and graphite

* Corresponding author.

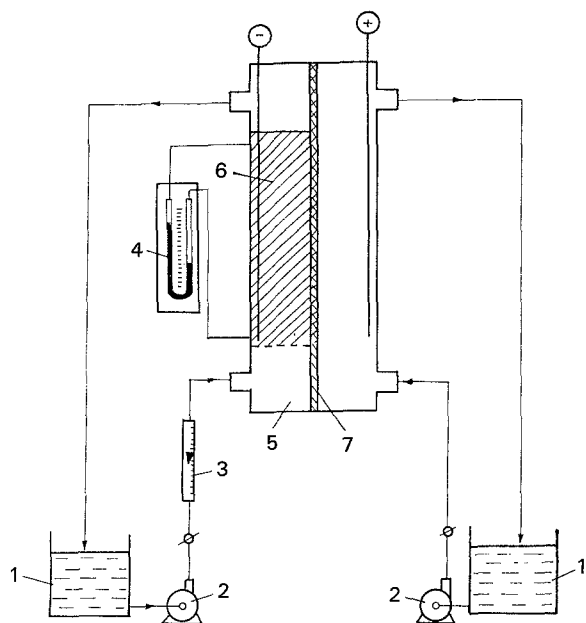

Fig. 1. Experimental setup; (1) tanks, (2) centrifugal pumps, (3) flowmeter, (4) U-tube manometer, (5) cell, (6) three-dimensional packed bed electrode and (7) diaphragm.

coated glass ballotini were used. The characteristics of the particles are given in Table 1.

Two series of experiments were carried out. In the first series copper ion depletion was carried out with monitoring of cell voltage, rate of winning, and pressure drop through the bed. In the second series of experiments, electrolysis of water served as a model system and only the pressure drop was measured. All experiments were carried out under galvanostatic conditions for different current densities and different hydrodynamic conditions. Experiments were conducted at ambient temperature.

3. Results and discussion

The pressure drop in the bed was periodically measured by means of the U-tube differential manometer filled with CCl_4 .

3.1. Pressure drop behaviour during copper deposition

For copper ion depletion, the change in the pressure drop with time is presented in Fig. 2. Pressure drop is expressed relative to the pressure drop in the absence of current (i.e., $\Delta P/\Delta P_0$) for different current densities.

It was observed that an increase in pressure drop

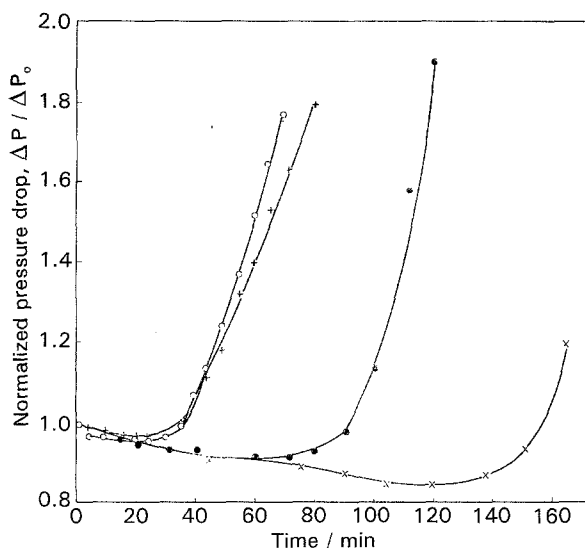

Fig. 2. Relative change of pressure drop with time during copper depletion. Bed material: copper scrap. Current density, i : (x) 271, (●) 386, (+) 580 and (○) 734 A m^{-2} .

coincided with the appearance of hydrogen evolution; thus the time intervals corresponding to approximately constant values of $\Delta P/\Delta P_0$ become shorter at the higher current density. The slight decrease in pressure drop prior to hydrogen evolution may be attributed to change in the particle micro-surface due to the deposition of fresh copper making them smoother. The large increase in $\Delta P/\Delta P_0$ when hydrogen evolution commences may be a consequence of several effects:

(i) Simultaneously with hydrogen evolution, copper deposits in powdered form causing the particle surfaces to become rougher, thus increasing friction losses in the bed.

(ii) Gas bubbles growing on the particles cause a change in their sphericity thus altering the tortuosity of the bed.

(iii) Hydrogen bubbles detaching from the particles make up a two-phase electrolyte thus changing the hydrodynamic conditions.

(iv) Bubbles attached to particles obstruct the electrolyte flow.

These effects influence, to various extents, the pressure drop through the bed, but their separate measurement is difficult.

There is a similarity between the shape of the curves in Fig. 2 and those depicting the cell voltage behaviour with time as shown in Fig. 3.

Table 1. Particle and bed characteristics

Packing type	Particle diameter/mm	Bed height/mm	Bed voidage
Copper spheres	2.25	75	0.410
	1.45	60	0.400
	1.15	80	0.396
Graphitized glass spheres	0.54	70	0.338
Copper cylinders	3.05*	85	0.440
Graphite Raschig rings	7.00*	105	0.545
Copper scrap	—	180	0.733

* Equivalent diameter.

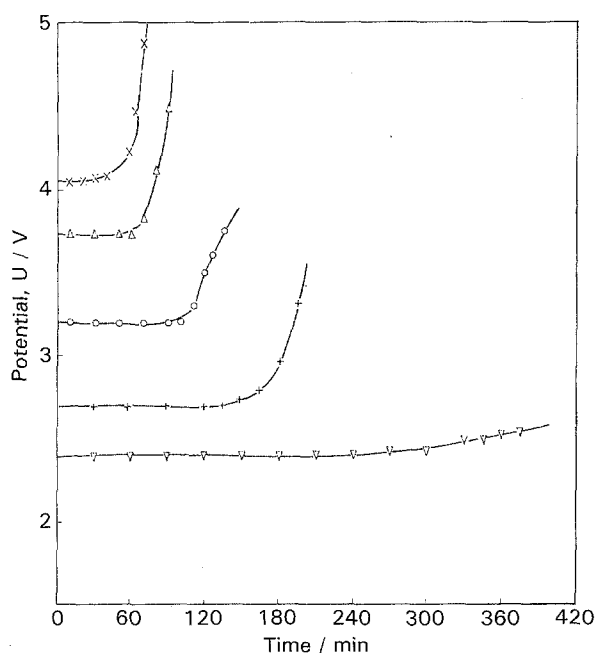

Fig. 3. Cell voltage against time during copper depletion. Bed material: copper scrap. Current density, i : (∇) 193, (+) 271, (\circ) 386, (Δ) 580 and (\times) 734 A m^{-2} .

Comparing the times when the cell voltage and pressure drop start to increase (Figs 2 and 3), it is seen that these are similar. As for the cell voltage behaviour with time, this has been discussed previously. The sharp cell voltage increase may be attributed mainly to the hydrogen overpotential appearance when the current density exceeds the instantaneous limiting current density [9–11].

Similar pressure drop behaviour as that obtained for copper scrap is obtained using copper spheres and graphite Raschig rings as shown in Fig. 4. The increase in $\Delta P/\Delta P_0$ occurs later in the case of copper spheres, even though the nominal current density is the same in both cases. However, this is a current density calculated on the basis of the current feeder surface. The real current density is lower in the case of the copper sphere bed because the specific surface is higher.

For graphite Raschig rings the $\Delta P/\Delta P_0$ situation is more complicated since the hydrogen evolution

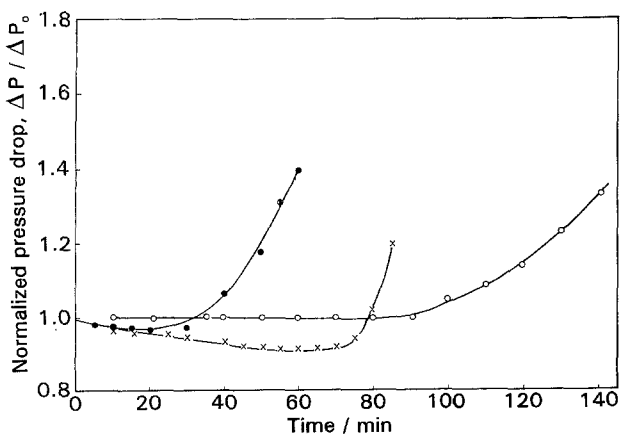

Fig. 4. Change of pressure drop with time during copper depletion; effect of particle shape. $i = 580 \text{ A m}^{-2}$; copper sphere size: 1.45 mm. Key: (●) copper scrap; (\times) copper spheres; (\circ) graphite Raschig rings.

potential is different on graphite partly covered by deposited copper. However, this figure broadly shows the pressure drop behaviour in beds of different packing when gas evolution occurs.

3.2. Pressure drop behaviour in water electrolysis

To eliminate the effect of particle surface change on the pressure drop caused by copper deposition and its removal as powdered copper, a second series of experiments was conducted in which the water electrolysis reaction was used in the three-dimensional fixed bed cathode of spherical particles (see Table 1). The results are presented in Fig. 5.

Pressure drop starts to increase immediately after switching on the d.c. current and tends to approach a constant value after a certain time. Two factors are also evident in Fig. 5, namely: (i) that $\Delta P/\Delta P_0$ increases with increasing current density; and (ii) that periods to reach a constant value of pressure drop become shorter at higher current densities. It may be supposed that the plateau on the curves corresponds to steady state conditions of hydrogen evolution, established after a certain time for given experimental conditions. Steady state is here defined as a state of equilibrium in which bubble growth and detachment become equal. For larger particles, the plateaux are less prominent especially at higher current densities, as shown in Fig. 6.

To check the influence on the pressure drop of the kind of gas evolved some experiments were performed with anodic polarization of the packed bed consisting of graphitized glass particles in contact with the lead sheet as the current feeder. Figure 7 shows experimental results for oxygen evolution in the packed bed and its influence on the pressure drop change with time. The curves are of the same shape as those presented in Figs 5 and 6. In this case the plateaux on the curves are well defined and steady state is reached earlier, but this is probably the consequence of the particle size. Thus, the same effect is obtained with oxygen evolution in the packed bed electrode.

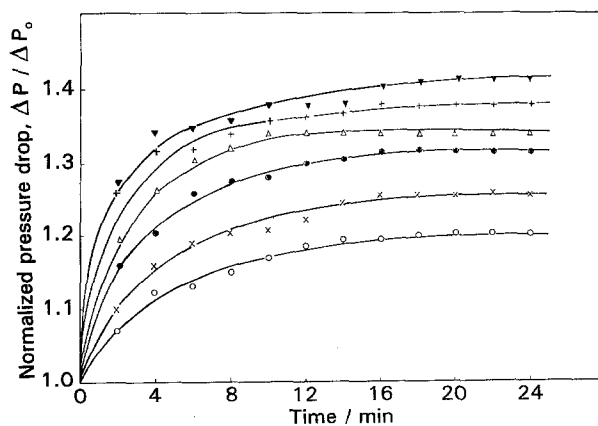

Fig. 5. Change of pressure drop with time for water electrolysis in the bed of copper spheres $d_p = 1.15 \text{ mm}$; $u = 0.026 \text{ m s}^{-1}$. Effect of current density, i : (\circ) 375, (\times) 500, (\bullet) 625, (Δ) 750, (+) 875 and (∇) 1000 A m^{-2} .

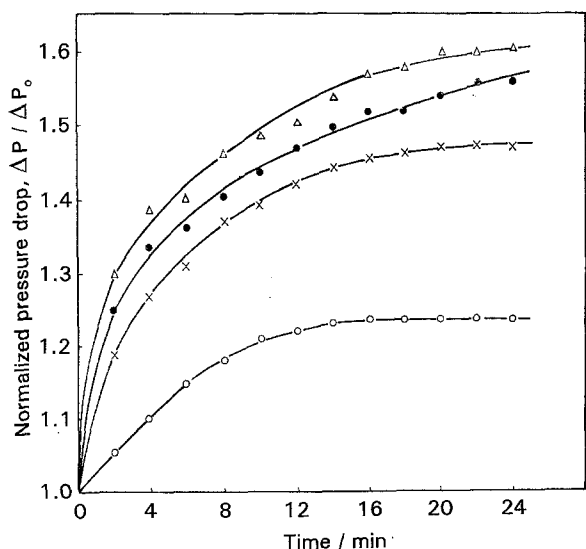

Fig. 6. Change of pressure drop with time for different current densities; hydrogen evolution on copper spheres $d_p = 2.25$ mm. Key: (O) 250, (x) 500, (●) 625 and (▲) 875 A m⁻².

The energy loss in a fluid flowing through a porous medium is defined by the well known Ergun equation:

$$\Delta p/L = 150 \frac{(1 - \epsilon)^2 \mu u}{\epsilon^3 d_p^3} + 1.75 \frac{(1 - \epsilon) \rho}{\epsilon^3 d_p} u^2 \quad (1)$$

where ΔP is the pressure drop in the bed, L is the bed height, ϵ is the bed voidage, μ is the electrolyte viscosity, u is the electrolyte velocity, d_p is the particle diameter and ρ is the electrolyte density.

This implies that for defined bed characteristics (d_p and ϵ) and constant electrolyte properties, $\Delta P/L$ is only a function of electrolyte velocity:

$$\frac{\Delta p}{L} = K_1 u + K_2 u^2 \quad (2)$$

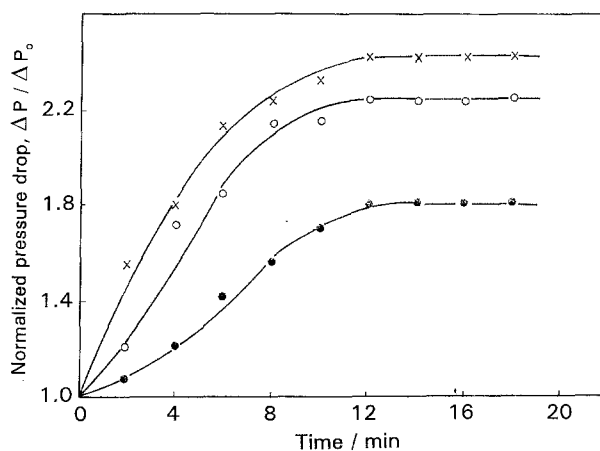

Fig. 7. Change of pressure drop with time for different current densities; oxygen evolution on graphitised spheres $d_p = 0.54$ mm. Key: (●) 285, (O) 570 and (x) 857 A m⁻².

where K_1 and K_2 are constants derived from Equation 1.

In the case of water electrolysis the bed surface quality remains constant but $\Delta P/\Delta P_0$ increases, as shown in Figs 5 and 7. Only the gas bubbles growing on the particles and moving into the electrolyte cause an increase in pressure drop in the bed. This implies that the influence of copper powder deposition has no significant effect on the pressure drop.

An experiment was carried out with the object of clarifying the pressure drop change with addition of copper ions to the electrolyte when $\Delta P/L$ had reached a constant value, thus causing an interruption to the hydrogen evolution reaction. The concentration of added copper ions was sufficiently high to prevent hydrogen evolution for a significant period at a given current density. Results are presented in Fig. 8. The

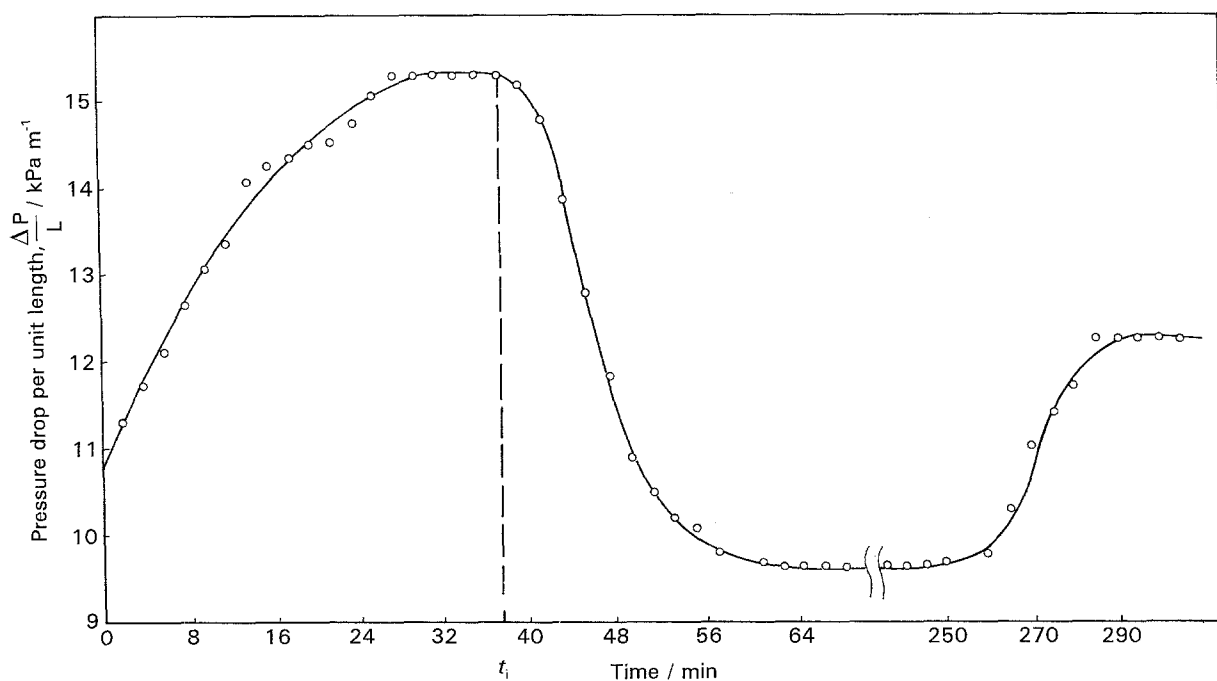

Fig. 8. Pressure drop behaviour for the consecutive hydrogen evolution and copper deposition reactions in the packed bed of copper spheres; t_i -time when the copper ions were added.

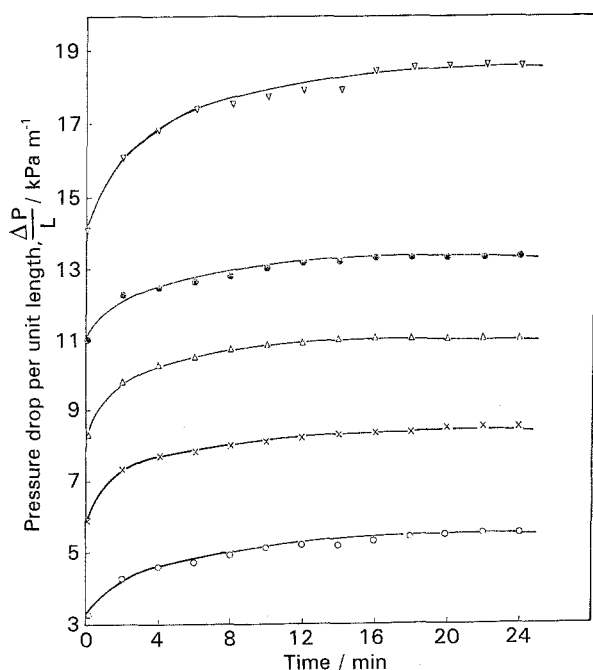

Fig. 9. Influence of electrolyte velocity on pressure drop behaviour against time; packed bed of copper spheres $d_p = 2.25$ mm, $i = 580$ A m⁻². Electrolyte velocity, $10u$: (○) 1.16, (×) 2.13, (△) 2.6, (●) 3.0 and (▽) 3.9 m s⁻¹.

time, t_1 , when the copper ions were introduced to the electrolyte is indicated on the graph. With addition of Cu²⁺-ions copper deposition takes place instead of hydrogen evolution and consequently, $\Delta P/L$ decreases. Residual hydrogen bubbles are removed from the bed with electrolyte flow so that this $\Delta P/L$ decrease does not occur suddenly, but after a certain period.

When the gas phase is completely removed from the bed the pressure drop reaches a constant value, which is maintained to the time when the copper ion concentration is depleted to the level when the operating current density again exceeds the limiting current density value and hydrogen evolution starts up again.

The lower $\Delta P/L$ plateau value than that found initially may be attributed to the change in particle surface microrelief caused by the fresh layer of deposited copper.

3.3. Effect of electrolyte flow-rate

The effect of the electrolyte velocity on the pressure drop behaviour is shown in Fig. 9 for a current density of 500 A m⁻². Curves of $\Delta P/L$ against t are displaced along the ordinate as expected from the Ergun equation and they are of the same shape as those presented previously. Moreover, the differences between the pressure drop when it reaches a constant value and the initial $\Delta P/L$ value remain independent of the electrolyte velocity.

Rearrangement of the Ergun equation leads to the dimensionless form

$$f_E = \frac{\Delta p d_p}{L u^2} \frac{\epsilon^3}{(1-\epsilon)} = 150 \frac{(1-\epsilon)}{Re} + 1.75 \quad (3)$$

where f_E is the friction factor.

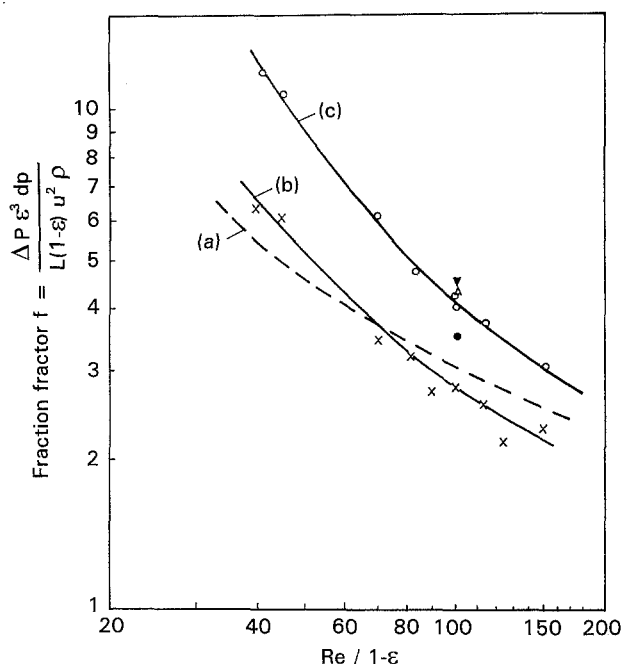

Fig. 10. Friction factor against modified Reynolds number for (a) Calculated using Equation 3. (b) Experimental data without gas evolution. (c) Experimental data for gas evolution at different current densities; $\Delta P/L$ are used at steady-state conditions. Current densities, i : (×) 0, (●) 250, (○) 500, (△) 625 and (▽) 875 A m⁻².

Introducing experimental results in Equation 3 for both $\Delta P/L$ without gas bubbles and with gas bubbles when the constant value of $\Delta P/L$ is reached a good agreement was obtained, as presented in Fig. 10.

The generation of gas bubbles on the particle flow causes an additional resistance to the electrolyte flow. The curves obtained are approximately parallel in the investigated range of Reynolds number. Thus the Ergun equation may be used to predict approximately the pressure drop in the case of gas evolution in a three dimensional packed bed electrode, but the coefficient in the first term of Equation 3 has a higher value. This coefficient is a function of current density i.e. the rate of hydrogen evolution.

References

- [1] F. Coeuret, *J. Appl. Electrochem.* **10** (1981) 676.
- [2] K. Kusakabe, H. Nishida, S. Morooka and Y. Kato, *ibid.* **16** (1986) 121.
- [3] G. Kreysa, *Chem. Ing. Tech.* **50** (1978) 33.
- [4] C. G. Millinger and D. Simonsson, *I. Chem. E Symposium Series* **112** (1989) 129.
- [5] V. D. Stanković and G. Milanov, Proceedings of the XXIV October meeting on 'Mining and Metallurgy', D. Milanovac, Yugoslavia; 1-3 Oct. (1992) p. 505.
- [6] G. Tosun, *Ind. Eng. Chem. Proc. Des. Dev.* **23** (1984) 35.
- [7] G. Song, F. Bavarian and L. S. Fan, *Can. J. Chem. Eng.* **67** (1989) 270.
- [8] V. D. Stanković and G. Lazarević, Proceedings of the meeting of 'Miners and Metallurgists', Bor Lake, Yugoslavia, Oct. (1993) p. 474.
- [9] J. A. E. Wilkinson and K. P. Haines, *Trans. Inst. Min. Met.* **81** (1973) C157.
- [10] V. D. Stanković and A. A. Wragg, *J. Appl. Electrochem.* **14** (1984) 615.
- [11] L. H. Mustoe and A. A. Wragg, *ibid.* **13** (1983) 507.